

APPROVAL SHEET

WLPN404010 Series Shielded SMD Power Inductors

*Contents in this sheet are subject to change without prior notice.

Features

1. Close magnetic loop with magnetic resin shielded.
2. Low profile, High inductance.

Applications

1. General propose power inductor in DC power system.
2. Inductor in DC/DC converter.
3. Low profile for portable and wearable device.
4. LC filter in Audio D class Amplifier.

Shape and Dimension

Unit: mm

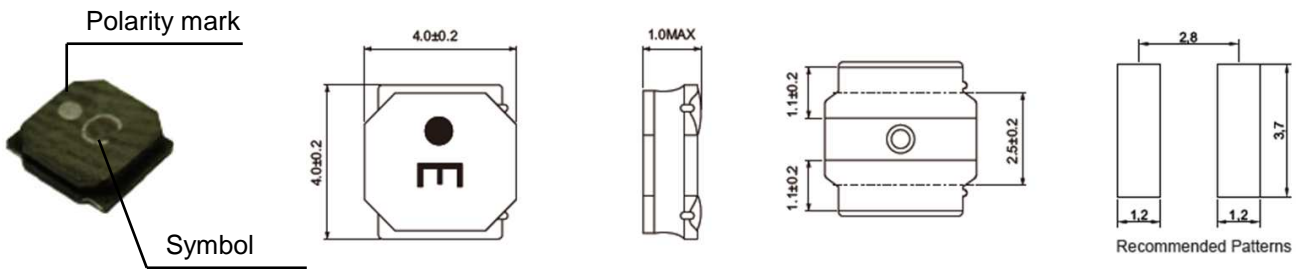

Ordering Information

WL	PN	4040	10	N	1R2	L	B
Product Code	Series	Dimensions	Thickness	Tolerance	Value	Packing Code	
WL: Inductor	Shielded SMD Power Inductors	4.0 * 4.0 mm	1.0 mm	M: ± 20% N: ± 30%	1R2 = 1.2uH 100 = 10uH	L=13" Reeled (Embossed Tape)	B:STD

Electrical Characteristics

WLPN404010 Series	L (uH)	Symbol	Inductance Tolerance	Test Freq (KHz)	DCR ($\Omega \pm 20\%$)	SRF (MHz)Min	Rated Current (mA) Max	
							Saturation Current Idc1	Temperature Rise Current Idc2
WLPN404010N1R0LB	1.0	A	$\pm 30\%$	100	0.056	116	2000	1900
WLPN404010M2R2LB	2.2	C	$\pm 20\%$	100	0.085	73	1200	1500
WLPN404010M3R3LB	3.3	E	$\pm 20\%$	100	0.100	58	1100	1400
WLPN404010M4R7LB	4.7	H	$\pm 20\%$	100	0.140	47	950	1200
WLPN404010M6R8LB	6.8	I	$\pm 20\%$	100	0.200	38	800	1000
WLPN404010M100LB	10	K	$\pm 20\%$	100	0.300	31	620	750
WLPN404010M150LB	15	M	$\pm 20\%$	100	0.430	24	540	600
WLPN404010M220LB	22	N	$\pm 20\%$	100	0.570	19	450	500

1. Test Frequency: 100KHz
2. Test Equipment:
Inductance: Chroma3302+1320+16502 or equivalent.
DCR: Chroma16502 or equivalent.
SRF: HP4291B or equivalent.
3. Saturation Current Idc1: The value of current causes a 30% inductance reduction from initial value.
4. Temperature rise current Idc2: The value of current causes a 40°C temperature rise.
5. Rated Current: Either Idc1 or Idc2 whichever is smaller.
6. Operating Temperature Range:-25°C to +120°C (Including self-temperature rise)
7. Storage Temp. Range : -40°C to +85°C.
8. MSL : Level 1

Structural Drawing

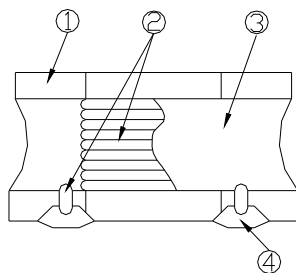

- ① Ferrite core : Ni-Zn ferrite
- ② Winding wire : Polyurethane-copper wire
- ③ Over-coating resin : Epoxy resin, containing ferrite powder
- ④ Electrode : External electrode (substrate) Cu
External electrode (top surface solder coating) Sn-Ag-Cu

Characteristic Curve

Inductance vs. DC Current

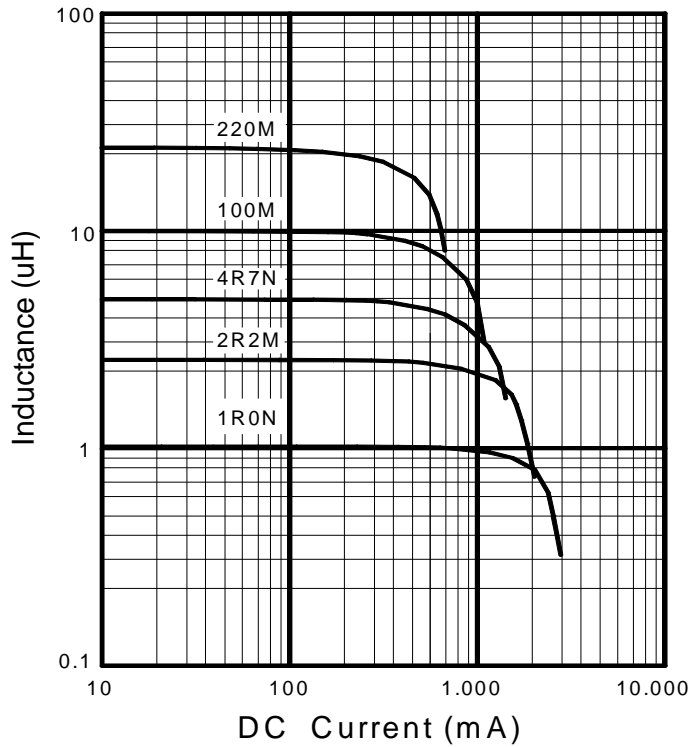

Core Chipping:

The appearance standard of the chipping size in top side, of bottom side ferrite Core is following dimension.

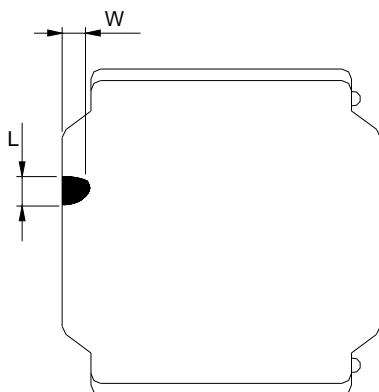

L	W
1.0mmMax.	1.0mmMax.

Exposed wire tolerance limit of coating resin part on product side
Size of exposed wire occurring to coating resin is specified below.

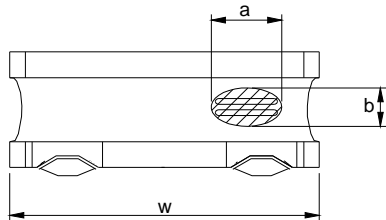

- ① Width direction (dimension a): Acceptable when $a \leq w/2$
 Nonconforming when $a > w/2$
- ② Length direction (dimension b): Dimension b is not specified.
- ③ When total area of exposed wire occurring to each sides is not greater than 50% of coating resin area, that is acceptable.

Reflow Profile Chart (Reference):

Typical RoHS Reflow Profile

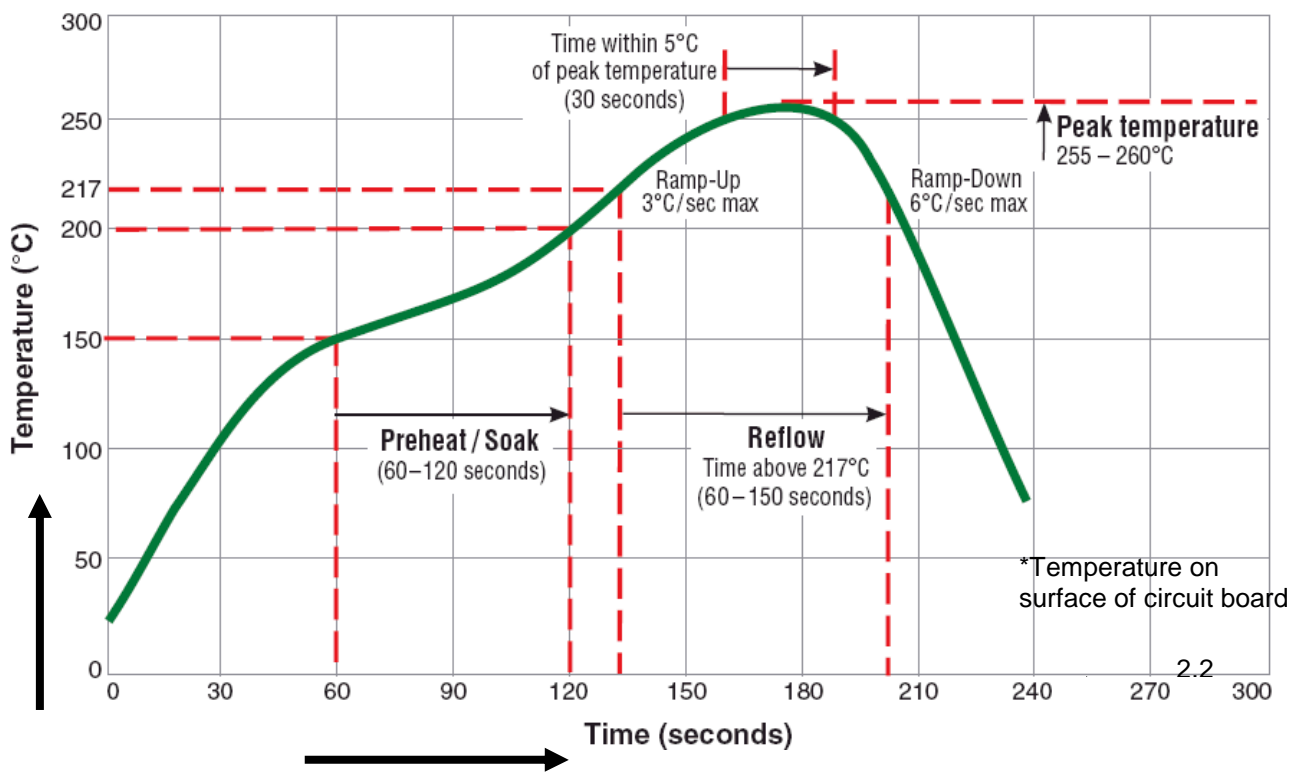

(Table 1)

The products may be exposed to reflow soldering process of above profile up to two times.

Mechanical Performance /Environmental Test Performance Specifications: (WLPN404010 series)

No.	Item	Test condition	Requirements								
1	Resistance to Deflection	No damage.	<p>The test samples shall be soldered to the test board by the reflow soldering conditions show in Table 1. As illustrated below, apply force in the direction of the Arrow indicating until deflection of the test board Reaches to 2 mm.</p> <p>Test board size :100×40×10 Test board material I: glass epoxy-resin Solder cream thickness:0.1</p> <p>Land dimensions Unit: mm</p>								
2	Adhesion of Terminal Electrode	Shall not come off PC board	<p>The test samples shall be soldered to the test board By the reflow soldering conditions shown in Table 1.</p> <p>Applied force: 10 N to X and Y directions Duration: 5 s. Solder cream thickness:0.1 mm (Refer to recommended Land Pattern Dimensions Defined in "Precaution")</p>								
3	Body strength	No damage	<p>Applied force :20 N Duration :10 s</p>								
4	Resistance to Vibration	<p>△L/L:within±10% No abnormality observed In appearance</p>	<p>The test samples shall be soldered to the test board by The reflow soldering conditions shown in Table 1.Then It shall be submitted to below test conditions</p> <table border="1"> <tr> <td>Frequency range</td> <td>10Hz~55Hz</td> </tr> <tr> <td>Total Amplitude</td> <td>1.5mm(May not exceed acceleration 196 m/S²)</td> </tr> <tr> <td>Sweeping Method</td> <td>10Hz to 55Hz to 10 Hz for 1 min.</td> </tr> <tr> <td>Time</td> <td>For 2 hours on each X, Y, and Z axis.</td> </tr> </table>	Frequency range	10Hz~55Hz	Total Amplitude	1.5mm(May not exceed acceleration 196 m/S ²)	Sweeping Method	10Hz to 55Hz to 10 Hz for 1 min.	Time	For 2 hours on each X, Y, and Z axis.
Frequency range	10Hz~55Hz										
Total Amplitude	1.5mm(May not exceed acceleration 196 m/S ²)										
Sweeping Method	10Hz to 55Hz to 10 Hz for 1 min.										
Time	For 2 hours on each X, Y, and Z axis.										
5	Resistance to Soldering heat (Reflow)	<p>△L/L:within±10% No abnormality observed In appearance</p>	<p>The test sample shall be exposed to reflow oven at 230±5 deg C for 40 seconds, with peak temperature at 260±5 deg C for 5 seconds, 2 times.</p> <p>Test board thickness:1.0 mm Test board material :glass epoxy-resin</p>								

6	Solder ability	At least 90% of surface of terminal electrode is covered by new solder.	The test samples shall be dipped in flux, and then Immersed in molten solder as shown in below table. Flux: Methanol solution containing rosin 25%												
			<table border="1"> <tr> <td>Solder Temperature</td> <td>245±deg C</td> </tr> <tr> <td>Time</td> <td>5±1.0 S.</td> </tr> <tr> <td>Immersing Speed</td> <td>25 mm/s</td> </tr> </table>	Solder Temperature	245±deg C	Time	5±1.0 S.	Immersing Speed	25 mm/s						
Solder Temperature	245±deg C														
Time	5±1.0 S.														
Immersing Speed	25 mm/s														
7	Temperature Characteristics	△L/L:within±20% No abnormality observed In appearance	Measurement of inductance shall be taken at temperature Range within -25 deg C to +85 deg C. With reference to inductance value at +20 deg C, change Rate shall be calculated.												
8	Thermal shock	△L/L:within±10% No abnormality observed In appearance	The test samples shall be soldered to test board By the reflow soldering conditions shown in Table 1. The test samples shall be placed at specified Shown in below table in sequence. The temperature cycle shall be repeated 100 cycles.												
			<p>Conditions of steps for 1 cycle</p> <table border="1"> <thead> <tr> <th>Step</th> <th>Temperature</th> <th>Time(min)</th> </tr> </thead> <tbody> <tr> <td>1</td> <td>-40±3 deg C</td> <td>30±3</td> </tr> <tr> <td>2</td> <td>Room Temp</td> <td>3 maximum</td> </tr> <tr> <td>3</td> <td>85±2 deg C</td> <td>30±3</td> </tr> <tr> <td>4</td> <td>Room Temp</td> <td>3 maximum</td> </tr> </tbody> </table>	Step	Temperature	Time(min)	1	-40±3 deg C	30±3	2	Room Temp	3 maximum	3	85±2 deg C	30±3
Step	Temperature	Time(min)													
1	-40±3 deg C	30±3													
2	Room Temp	3 maximum													
3	85±2 deg C	30±3													
4	Room Temp	3 maximum													
9	Low Temperature life Test	△L/L:within±10% No abnormality observed In appearance	The test samples shall be soldered to the test board by The reflow soldering conditions shown in Table 1. After that, the test samples shall be placed at test Conditions as shown in below table.												
			<table border="1"> <tr> <td>Temperature</td> <td>-40±2 deg C</td> </tr> <tr> <td>Time</td> <td>500 +24/-0 h</td> </tr> </table>	Temperature	-40±2 deg C	Time	500 +24/-0 h								
Temperature	-40±2 deg C														
Time	500 +24/-0 h														
10	Loading at high temperature life test	△L/L:within±10% No abnormality observed in appearance.	The test samples shall be soldered to the test board by the reflow soldering conditions shown in Table 1. The test samples shall be placed in thermostatic oven set at specified temperature and applied the rated current continuously as shown in below table.												
			<table border="1"> <tr> <td>Temperature</td> <td>85±2 deg C</td> </tr> <tr> <td>Applied current</td> <td>Rated current (Refer to Page 2)</td> </tr> <tr> <td>Time</td> <td>500+24/-0 h</td> </tr> </table>	Temperature	85±2 deg C	Applied current	Rated current (Refer to Page 2)	Time	500+24/-0 h						
Temperature	85±2 deg C														
Applied current	Rated current (Refer to Page 2)														
Time	500+24/-0 h														
11	Damp heat life test	△L/L:within±10% No abnormality observed in appearance.	The test samples shall be soldered to the test board by the reflow soldering conditions shown in Table 1. The test samples shall be placed in thermostatic oven set at specified temperature and humidity as shown in below table.												
			<table border="1"> <tr> <td>Temperature</td> <td>60±2 deg C</td> </tr> <tr> <td>Humidity</td> <td>90~95%RH</td> </tr> <tr> <td>Time</td> <td>500+24/-0 h</td> </tr> </table>	Temperature	60±2 deg C	Humidity	90~95%RH	Time	500+24/-0 h						
Temperature	60±2 deg C														
Humidity	90~95%RH														
Time	500+24/-0 h														
12	Loading under Damp heat life test	△L/L:within±10% No abnormality observed in appearance.	The test samples shall be soldered to the test board by the reflow soldering conditions shown in Table 1. The test samples shall be placed in thermostatic oven set at specified temperature and humidity and applied the rated current continuously as shown in below table.												
			<table border="1"> <tr> <td>Temperature</td> <td>60±2 deg C</td> </tr> <tr> <td>Humidity</td> <td>90~95%RH</td> </tr> <tr> <td>Applied current</td> <td>Rated current (Refer to Page 2)</td> </tr> <tr> <td>Time</td> <td>500+24/-0 h</td> </tr> </table>	Temperature	60±2 deg C	Humidity	90~95%RH	Applied current	Rated current (Refer to Page 2)	Time	500+24/-0 h				
Temperature	60±2 deg C														
Humidity	90~95%RH														
Applied current	Rated current (Refer to Page 2)														
Time	500+24/-0 h														

Tape & Reel Packaging Dimensions:

Dimensions Unit: mm

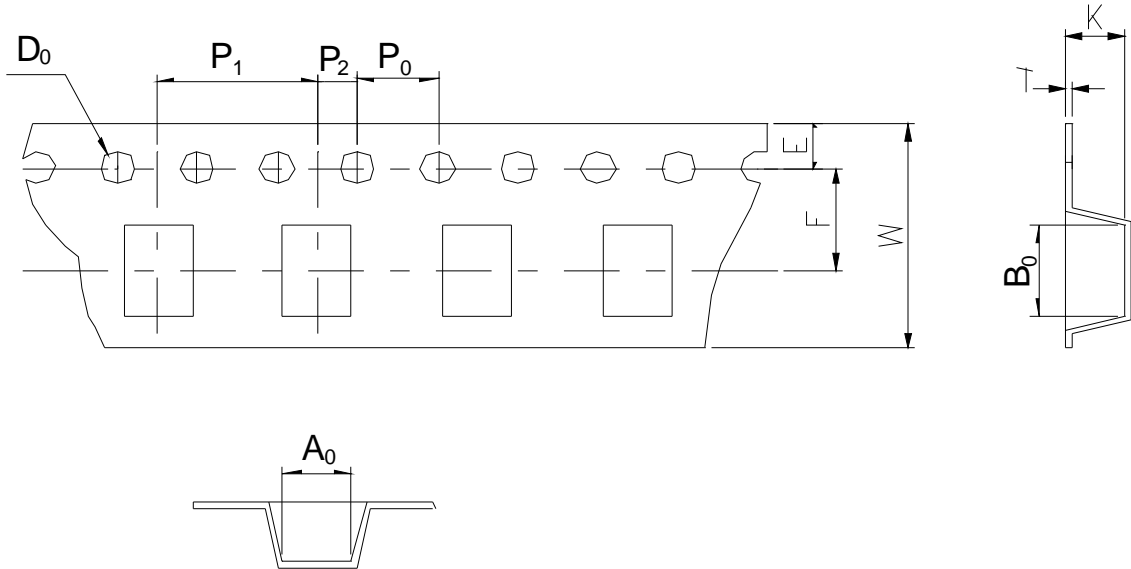

A_0	B_0	W	F	E	P_1	P_2	P_0	D_0	T	K
4.3 ± 0.1	4.3 ± 0.1	12.0 ± 0.3	5.5 ± 0.1	1.75 ± 0.1	8.0 ± 0.1	2.0 ± 0.1	4.0 ± 0.1	$\Phi 1.5$ $+0.1$ -0	0.3 ± 0.05	1.4 ± 0.1

Direction of rolling

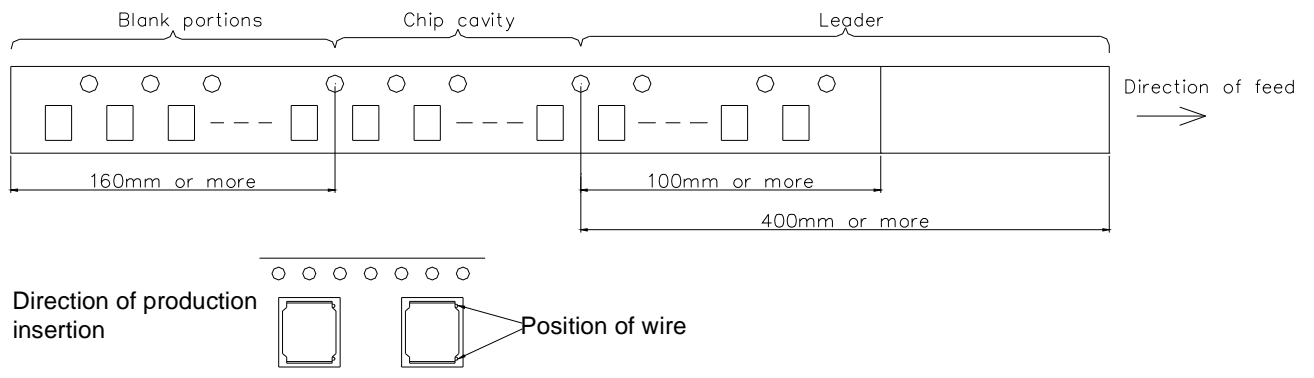

Reel

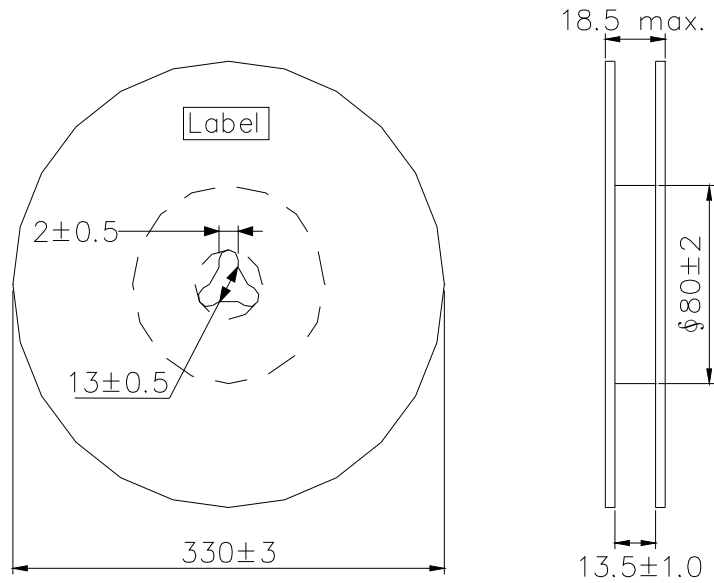

Top tape strength

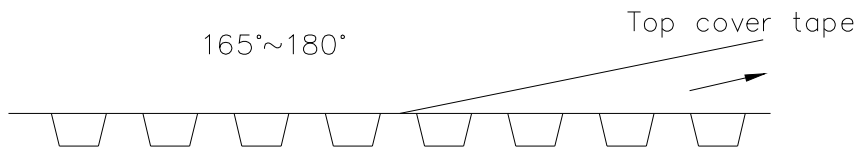

Peel-off strength: 0.1N~1.3N

Peel-off angle: $165^\circ \sim 180^\circ$

Peel-off speed: 300mm/mm

Quantity per reel : 5K pcs